



**FRONTIER**

**Crossman**<sup>®</sup>

OWNER'S MANUAL

**PEACEMAKER**

Please read this Owner's Manual carefully, and thoroughly before operating gun.

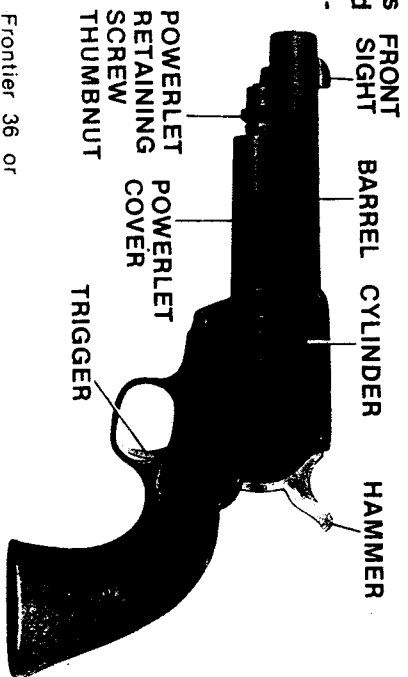

As the owner of your Frontier 36 or Peacemaker 44 revolver, Crosman Arms welcomes you to the ever increasing number of sportsmen and shooting enthusiasts who have chosen Crosman Guns.

The revolvers are precision built, CO2 powered, single action revolvers. Engineered from finest quality material, the guns are designed to combine high performance with inexpensive shooting. The Frontier 36 operates as a .177 caliber, 18-shot, BB revolver. The Peacemaker 44 operates as a .22 caliber, 6-shot pellegun revolver.

## SPECIFICATIONS

Before your revolver was released from our factory, it had undergone numerous rigid inspections and had been test fired to guarantee its performance. Your revolver is under compression at the time of purchase, as a POWERLET® has been fitted at the factory to provide power for factory testing. Residual CO2 contained in the gun must be completely used or exhausted before removing POWERLET for recharging. Refer to complete instructions in this manual.

With normal care and maintenance your revolver will last a life time and provide endless pleasure. You are urged to use the revolver with respect for other people and to exercise caution and common sense at all times. Care should be taken not to alter or adjust any of the factory settings to the trigger, or to interfere with any other part of the gun that may impair its safe operation.

<b>Mechanism</b>	Single action
Model 36	Single action
Model 44	
<b>Caliber</b>	
Model 36	.177
Model 44	.22
<b>Ammunition</b>	Crosman SUPER BB's®
Model 36	Crosman SUPER PELLETS
Model 44	
<b>Cylinder Capacity</b>	
Model 36	6 BB's
Model 44	6 Pellets
<b>Magazine</b>	
Model 36	18 BB's (including 6 in cylinder)
Model 44	None
<b>Weight</b>	
Model 36	2 lb., 2 oz. (.965 gr)
Model 44	2 lb., (910 gr)
<b>Overall Length</b>	10-3/8 in. (265 mm)
<b>Barrel</b>	
Model 36	Steel, smooth bore
Model 44	Steel, button rifled, 10 lands.
<b>Power Source</b>	One Crosman 12.5 gr. POWERLET

## SHOOTING THE REVOLVER

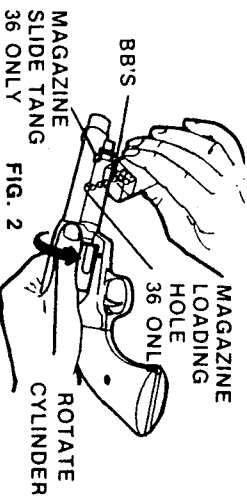

### TO LOAD THE FRONTIER 36

Point the revolver in a safe direction. Push the BB Follower slide fully forward and locate it in the holding slot (Fig. 2). With the revolver upside down and slightly upward, load Crosman SUPER BB's into the Magazine Loading Port until the Magazine is full. Hold the revolver with the muzzle upward and slowly rotate the Cylinder, allowing the BB's to roll into each of the six chambers in the Cylinder. Then hold the revolver as before and continue to load more BB's into the Magazine Loading Port. The Magazine is full when a total of 18 BB's have been

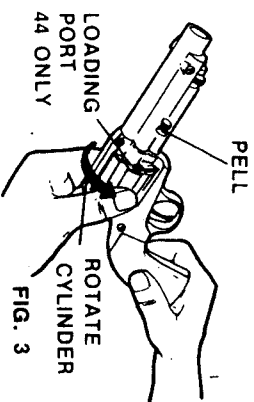

loaded. Release the BB Follower slide from the holding slot.

### TO LOAD THE PEACEMAKER 44

Point the revolver in a safe direction and rotate the Cylinder until a chamber is aligned with the Loading Port. Load a Crosman SUPER PELL, nose toward the muzzle, into the Loading Port (Fig. 3) making sure the pell seats down in its chamber. Rotate the Cylinder to align the next chamber with Loading Port and load a SUPER PELL into the port. Repeat the procedure until all the chambers are loaded.

### TO SHOOT THE PEACEMAKER 44 AND FRONTIER 36

Point the revolver in a safe direction and pull back the Hammer with the thumb to the fully rearward position. This action revolves the Cylinder, placing the next pellet or BB in line with the Barrel, locks the Cylinder in position and cocks the revolver ready to fire. When you are sure of your target and backstop, take aim and squeeze the trigger gently to fire.

### TO UNLOAD THE REVOLVER

**The Frontier 36**  
Be sure the revolver is not cocked. Push the BB Follower slide fully forward and locate it in the holding slot. Hold the

revolver with the muzzle downward. Rotate the Cylinder slowly, stopping at each of the six click positions for each BB to drop out of the chambers. The BB's will drop out of the Magazine Loading Port. Shake the revolver gently to insure that no BB's remain in the Magazine.

**The Peacemaker 44**  
Be sure the revolver is not cocked. Revolve the Cylinder to align each chamber in turn with the Loading Port. Gently tap the revolver to eject the Pells from each chamber. Pells may also be picked out of the chambers with a pointed instrument. Revolve the cylinder to check that each chamber is clear.

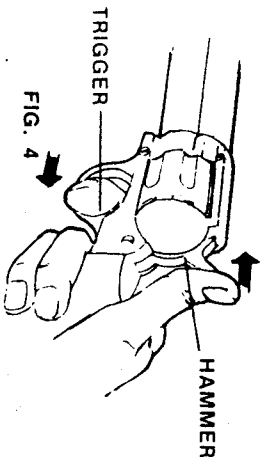

FIG. 4

**TO CHARGE REVOLVER WITH CO<sub>2</sub> GAS**  
 Before replacing a CO<sub>2</sub> gas POWERLET, remove all the BB's remaining in the Magazine and Cylinder of the Frontier 38 and all the Pellets from the Cylinder of the Peacemaker 44, then proceed as detailed in the following instructions.

**TO EXHAUST CO<sub>2</sub> GAS**  
 Point the revolver in a safe direction, cock the Hammer as far back as possible. Squeeze the Trigger and, without releasing it, push the Hammer forward with the thumb until the gas can be heard to be

escaping (Fig. 4). Cock the Hammer and shoot, repeating several times to be certain that all the CO<sub>2</sub> gas is exhausted. Turn the Powerlet Retaining Nut clockwise until the POWERLET can be withdrawn. Remove the POWERLET cover.

**CAUTION:** Do not allow exhaust gas to come in contact with the flesh as exhaust CO<sub>2</sub> gas can cause frostbite.

**TO REPLACE THE POWERLET**  
 Place the cover on the new POWERLET and, with the neck pointing toward the

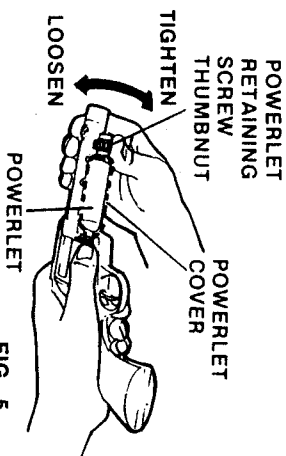

FIG. 5

Cylinder, insert the POWERLET into the gun. Hold the POWERLET straight and turn the retaining nut counterclockwise with the fingers until the POWERLET is completely secured (Fig. 5). DO NOT use pliers or other tools to turn the Powerlet Retaining Nut as damage to the internal components of your revolver can be caused. Point the revolver in a safe direction and cock the Hammer. Shoot, repeating several times to pierce the POWERLET.

### USE CROSMAN POWERLETS® ON

Top-performance CO<sub>2</sub> cartridges, made by Crosman for Crosman guns. Perma-Lok caps assure positive seal, clean piercing. Zinc-chromium plating, no rust, scale or grease.

12.5 gram "giant" size  
 box of 5-Model 231/5

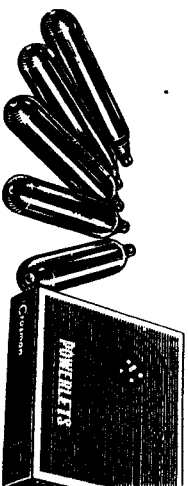

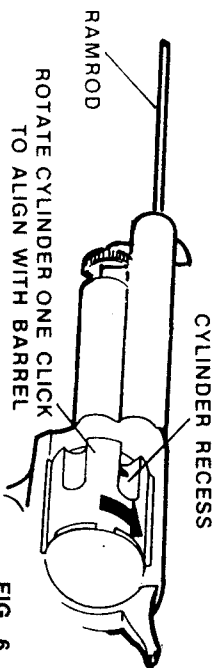

FIG. 6

**TO UNLOAD A BB OR PELL FROM THE BARREL**

If a BB, Pell or other obstruction has become lodged in the Barrel, exhaust the CO<sub>2</sub> gas and remove the POWERLET as described in the section, "To Exhaust CO<sub>2</sub> Gas".

**The Frontier 36**

To remove all remaining BB's from the Magazine and Cylinder as described in the section, "To Unload The Revolver": Insert a 5/32 in. (4 mm) diameter ramrod into the muzzle end of the Barrel and push the obstruction back into an empty chamber. Rotate the Cylinder to align the chamber

with the Magazine. Hold the revolver with the muzzle downward and gently shake the obstruction out of the Magazine Loading Port.

**The Peacemaker 44**

Remove all remaining Pellets from the Cylinder as described in the section, "To Unload the Revolver". Rotate the Cylinder to align the deep recess in the Cylinder with the Barrel (Fig. 6). Insert the ramrod provided with your revolver into the muzzle end of the Barrel. Push the Pell gently down the Barrel into the recess. Rotate the Cylinder and the Pell will fall out.

**SIGHTING-IN THE REVOLVER**

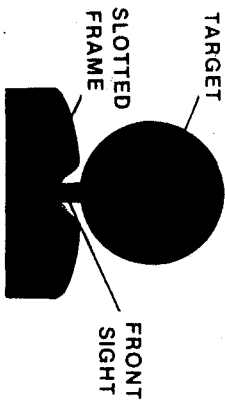

FIG. 7

When taking aim it is important to stand steady with the feet slightly apart. Grip the revolver firmly, extend your arm fully to the side at shoulder level, and point directly at the target. Line up a perfect sight picture (Fig. 7). Place your other hand on the hip with your elbow slightly bent. The revolver is correctly aimed with the blade of the

Front Sight is centered in the "V" of the Slotted Frame. For target shooting, many marksmen prefer to sight-in at the bottom of the bull's eye (the 6 o'clock position). The sights will then appear black against the white of the target. The point of impact, however, will be the center of the bull's eye.

## CARE OF THE REVOLVER

### REPAIR SERVICE

It is recommended that in the event of repairs being necessary to your rifle, the work be entrusted only to your nearest Crosmen Authorized Service Station. Fully equipped and manned by specially trained staff, the world-wide network of Service Stations has been established to provide fast, efficient, local service. In areas where no repair service is available a Repair Manual may be obtained, price \$1.50, from Crosmen Arms Company, 980 Turk Hill Road, Fairport, N. Y. 14450, U.S.A.

Treat your revolver with the same fine care that you would give your other valued possessions and it will give you a life time

of service, pleasure and enjoyment. Be sure the revolver is unloaded when not in use. Always keep your revolver clean. Insure that dirt and grit do not enter the Barrel, Cylinder, or other moving parts. Gently wipe metal parts with a cloth moistened with Crosmen PELLGUNOIL® to prevent rust and to preserve the finish.

For greatest accuracy, long barrel life and trouble-free performance, use only Crosmen ammunition. The design and materials of other ammunition could cause loading failures, plugged barrel and permanent damage to your revolver. DO NOT expose charged revolver or POWER-LETS to excessive heat.

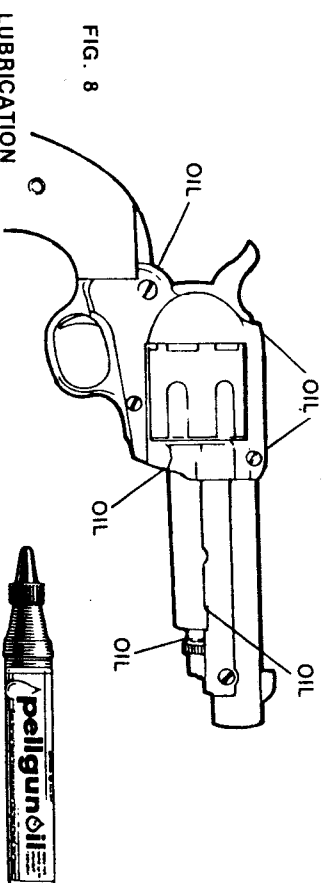

FIG. 8  
LUBRICATION

Be sure to follow these simple instructions to insure the long life of your revolver. To maintain trouble-free performance and eliminate most sealing failures, after every 250 shots or when moving parts appear dry, apply 2 or 3 drops of PELLGUNOIL (Fig. 8). Apply 2 drops of PELLGUNOIL to the piercing pin and external seal in the Piercing Assembly every 250 shots when the POWERLET is replaced. Be sure the O-ring on the Piercing Assembly is clean and free of

foreign matter which could cause excessive wear or damage.

DO NOT over oil as harm may be caused to the gun action. DO NOT use penetrating, detergent, or regular gun oils as damage may be caused to the valve washers, seals and finish.

It is not necessary to clean the Barrel bore, but the occasional application of a little PELLGUNOIL is recommended to prevent the Barrel from rusting.

**CROSMAN AMMUNITION IS GUARANTEED FOR BEST SHOOTING RESULTS, LONGER GUN LIFE.**

**CAUTION**

The following suggestions are intended to serve as a useful reminder.

- DON'T forget to treat every gun as if it is loaded.
- DON'T alter or adjust any of the factory settings to your revolver.
- DON'T reuse ammunition that has already been fired.
- DON'T attempt to clear a Pell jammed in the Barrel by shooting it out with another Pell.
- DON'T shoot steel darts as the accuracy of your revolver may be impaired or personal injuries may result.
- DON'T use any ammunition other than Crosman SUPER BB's for the Frontier 36 and Crosman SUPER PELLEs for the Peacemaker 44.
- DON'T point the revolver in an unsafe direction.
- DON'T point the revolver at anything you do not intend to shoot.
- DON'T attempt to squeeze the Trigger without cocking the revolver as damage can be caused to the gun action.
- DON'T shoot at the target until you are sure of your backstop.
- DON'T shoot your revolver when the POWERLET is low in gas pressure.
- DON'T expose charged revolver or POWERLETS to excessive heat or cold.
- DON'T over lubricate your revolver.
- DON'T store your revolver loaded.
- DON'T use your revolver without due respect for yourself or other people.
- DON'T conduct yourself in an unsportsman-like manner when using your revolver.