

Handbook
Manual de instrucciones
Manuel d'instructions
Bedienungsanleitung
Manual de instruções

Carabine. Break Barrel
Carabina. Cañón Abatible
Carabine. Canon Pliant
Luftgewehr. Kipplauf
Carabina. Cano Dobravel

DANGER: *Read this manual and the warnings and safety procedures pamphlet prior to handling this product.*

PELIGRO: *Lea atentamente este manual y todas las instrucciones de seguridad antes de manipular esta carabina.*

DANGER: *Lire impérativement ce manuel, et plus particulièrement les précautions d'utilisation et de sécurité avant toute utilisation du produit.*

ACHTUNG: *Lesen Sie diese Bedienungsanleitung sorgfältig bevor Sie das Produkt anfassen oder gar benützen.*

ATENÇÃO: *Leia atentamente o manual e todas as instruções de segurança antes de utilizar esta carabina.*

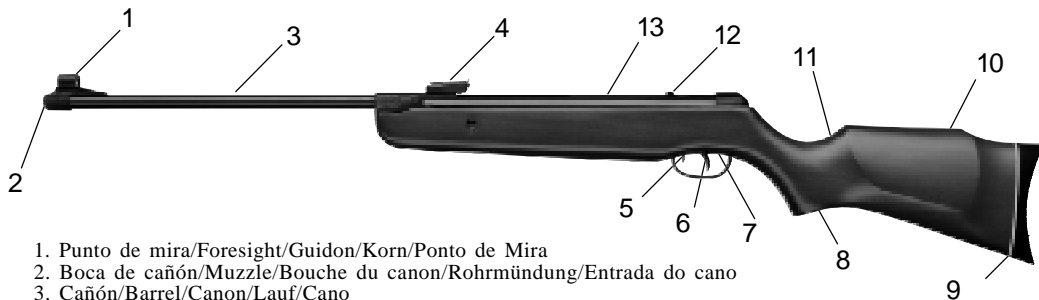

1. Punto de mira/Foresight/Guidon/Korn/Ponto de Mira
2. Boca de cañón/Muzzle/Bouche du canon/Rohrmündung/Entrada do cano
3. Cañón/Barrel/Canon/Lauf/Cano
4. Alza/Rear sight/Hausse/Visier/alça
5. Seguro Manual/Manual safety/Sûreté manuelle/Manuelle Sicherung/Segurança
6. Gatillo regulable/Two-stage trigger/Détente réglable/Regulierbarer Abzugshebel/Gatilho
7. Tornillo de regulación/Trigger adjustment screw/Vis de réglage/Regulierschraube/Parafuso de Regulação (*)
8. Empuñadura/Grip/Poignée/Griff/Empunhadura
9. Culatín/Buttplate/Plaque de couche/Schulterstütze/Chapa de Couce
10. Carrillera/Cheekpiece/Pièce de joue/Backenauflage/Camára
11. Culata/Stock/Crosse/Gewehrkolben/Coronha
12. Tope visor/Scope stop/Semelle du viseur/Visieranschlag/Amortecedor do visor (*)
13. Adaptador de visor/Scope Rail/Adaptateur de viseur/Visieradapter/Adaptador do visor

(*) Según modelo/According to model/Selon modèle/Je nach Modell/Mediante o Modelo

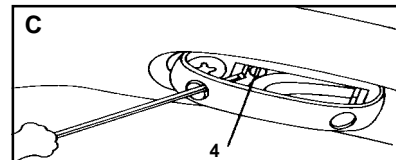
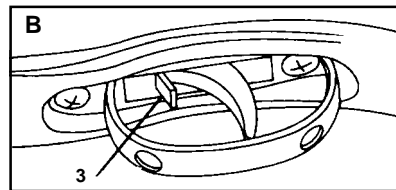
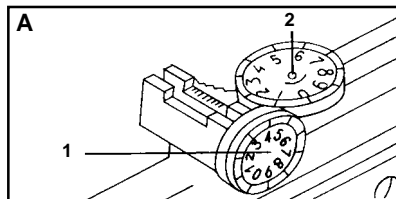
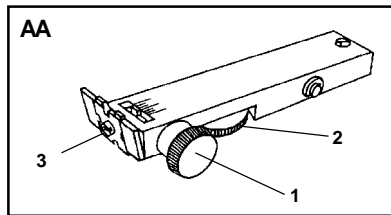
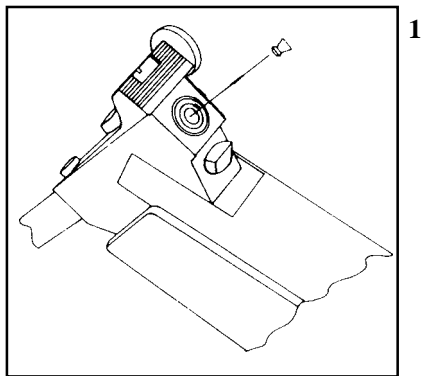

⑤ Correct shot
Disparo correcto
Tir correct
Richtiger Schuss
Disparo correcto

⑥ Incorrect shot
Disparo incorrecto
Tir incorrect
Unrichtiger Schuss
Disparo incorrecto

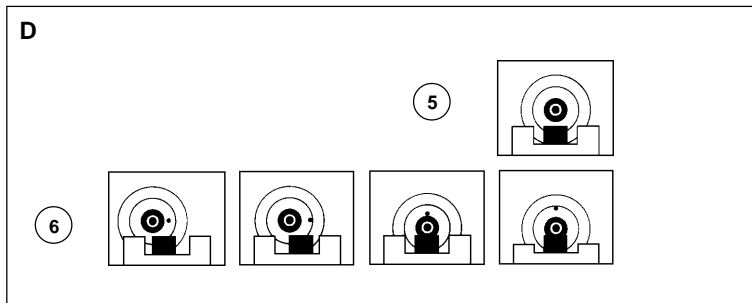

INTRODUCTION

Before you use your new GAMO AIR GUN you must read and understand the following safety rules:

WARNING: This is not a toy. Failure to follow the safety rules outlined below can result in serious bodily injury or death.

CAUTION: This product is not recommended for unsupervised use by those under 16 years of age.

CAUTION: This product is designed to handle and function like a rifle. Do not carry or use this product in any situation where it might be mistaken for a firearm.

SAFETY RULES

Anytime you handle your GAMO air gun, make sure the safety catch is “ON” and there is no ammunition in the entrance to the magazine.

- 1. ALWAYS USE EYE PROTECTION.**
 - 2. ALWAYS USE HEARING PROTECTION.**
 - 3. Air guns are not toys. They should only be used under adult supervision. Safety is a straightforward but continuous process. THE UNSUPERVISED USE OF AIR GUNS IS NOT RECOMMENDED FOR PERSONS UNDER 16 YEARS OF AGE.**
 - 4. Think first, fire second.**
 - 5. Always point the gun in a safe direction. NEVER POINT YOUR AIR GUN AT PEOPLE OR ANIMALS EVEN IF IT IS NOT LOADED.**
 - 6. Always keep your fingers away from the trigger during cocking and handling. Keep your finger away from the trigger until you are ready to fire.**
 - 7. Always be certain of what is behind your target. Make sure your target does not conceal a person or some object which could be harmed by the pellets.**
 - 8. Do not fire at a target which allows ricochets or deflections. Do not fire into or at water.**
 - 9. Never use drugs or alcohol while handling this product.**
-

- 10.** Never reuse pellets.
- 11.** The air gun and pellets should be kept in separate places, if possible under lock and key.
- 12.** After use and before putting the air gun away, always make absolutely sure that there are no pellets in the chamber.
- 13.** Do not load the air gun until you are ready to fire. Do not walk, run or jump when carrying a loaded air gun. A loaded air gun should never be carried inside a vehicle. Always keep the safety ON, even when the air gun is unloaded.
- 14.** Do not tamper with or modify any part of your air gun. If a malfunction should occur, consult a professional gunsmith. Do not attempt to repair your air gun, since special tools are needed and this could be dangerous.
- 15.** ALWAYS KEEP THE AIR GUN AND/OR PELLETS OUT OF THE REACH OF CHILDREN.

OPERATION OF THE SAFETY

WARNING: There is no substitute for muzzle control. Never rely on any mechanical safety. Always point the gun in a safe direction.

The safety catch is located in front of the trigger (see fig. B). The safety is on when the lever is in the rear position (near the trigger). To release the trigger, move the lever to the forward position (away from the trigger).

WARNING: Always put the safety “ON” when handling, carrying, loading or unloading the air gun.

CAUTION: Do not press the trigger while putting the safety “ON”.

TRIGGER ADJUSTMENT

WARNING: Be sure the air gun is not loaded before adjusting trigger

WARNING: There is no substitute for muzzle control. Never rely on any mechanical safety. Always point the gun in a safe direction.

This gun is supplied with a trigger with an adjusting screw for second stage length (see fig. C-4). Adjustment is carried out as follows: for reduction -rotate screw clockwise, for increase -rotate screw counter-clockwise.

WARNING: Always put the safety “ON” when handling, carrying, loading or unloading the air gun.

LOADING

WARNING: Before loading or firing your air gun for the first time, pass a cleaning rod through the bore to make sure it is free of obstructions.

WARNING: Always put the safety “ON” when handling, carrying, loading or unloading the air gun.

Open the barrel by placing the stock of the gun on your hip and grasping the end of the barrel firmly and pulling it down and toward you until it catches. With the gun in this position, load the gun by placing a pellet (always with the skirt end toward you) in the opening of the barrel (see fig. 1), then pull the barrel back to its original position until it locks into place.

WARNING: Remember that the gun is loaded and the pellet is in position to fire.

FIRING

WARNING: Always put the safety “ON” when handling, carrying, loading or unloading the air gun.

CAUTION: Keep your finger away from the trigger until you are ready to fire. To fire your air gun, aim at your target, release the safety, and gently squeeze the trigger.

WARNING: If a pellet becomes lodged inside the barrel, refer to the "PROCEDURE FOR CLEARING STUCK AMMUNITION" section.

WARNING: Each time the air gun is to be put away after use, please ensure that the last round has been fired, that the magazine is completely empty, and that the air gun is not longer cocked. This will prevent the possibility of accidents occurring when the air gun is used again.

PROCEDURE FOR CLEARING STUCK AMMUNITION

WARNING: Do not touch face or mouth after handling pellets. Wash hands after handling pellets.

WARNING: NEVER attempt to clear stuck ammunition by firing an additional pellet through the gun.

CAUTION: Be sure that the safety catch is «ON» prior to clearing an obstruction.

Break the barrel down the same as in loading, and insert a cleaning rod of the appropriate caliber for your rifle (.177 or .22) into the opening of the barrel. Push the rod through the barrel until the pellet is free. When you are finished, clean the barrel with the brush attachment of the cleaning rod to remove any lead particles that may be adhered to the rifling.

NOTE: Always discard defective or deformed ammunition.

WARNING: Each time the air gun is to be put away after use, please ensure that the last round has been fired, that the magazine is completely empty, and that the air gun is not longer cocked. This will prevent the possibility of accidents occurring when the air gun is used again.

CAUTION: When you are ready to put your gun away, with the barrel pointed toward the floor, make sure that there is no ammunition in the barrel. This way you will prevent any possible accident the next time you use your gun.

SIGHT PICTURE AND ADJUSTMENT

Your GAMO AIR RIFLE has a rear sight which is adjustable for windage (right-left) and elevation (up-down). The sights are “open” sights. The rear sight is a notch. The front sight is a post. The sight picture should look like the examples (fig. D).

Windage adjustment

If the shot is deflected to the left of the target, turn the screw 1 (fig. A or AA) clockwise. If the shot deflected to the right of the target, turn the screw counter-clockwise.

Elevation adjustment

If the shot is too high, turn the screw 2 (fig. A or AA) clockwise. If the shot is too low, turn the screw counter-clockwise.

Changing the position of the sight

On some rifle models, the sight has a part with 4 interchangeable positions. Undo the screw 3 (fig. A) until the sight rotates outside its housingtop. Tighten screw 3 up again while holding the sight with your other hand until it slots back into the sight-holder.

STORAGE

WARNING: Airguns should be stored in such a manner to protect against unauthorized use by children.

WARNING: These products are designed to look, handle and function like rifles. These products should be stored in such a manner to protect against theft and subsequent misuse.

You should never store your Gamo air gun unless it has been cleaned and given a light coat of oil. Always store your Gamo rifle in a clean dry place. It is recommended that you store this product in a GAMO case with appropriate anti-corrosion materials. A local gun shop can advise you on appropriate products available in your area.

CAUTION: When storing your rifle, always make sure it is unloaded and the safety in “ON”.