



HATSAN
ARMS COMPANY



MOD 33 / MOD 35 / MOD 35S
MOD 40 / MOD 45

Durable, Strong & Deluxe Break-Barrel Rifle

Robustes Deluxe-Luftgewehr mit Kippspannung

Résistant, Carabines Luxe à Canon Basculant

**Rifle de aire Comprimido con acción de quiebre,
durable, resistente y de lujo**

Instruction manual 

GB

Bedienungsanleitung 

DE

Manuel d'instruction 

FR

Manual de instrucciones 

ESP

Thank you for choosing MOD 35 / MOD 35S / MOD 33 / MOD 40 / MOD 45

Section I. Basic Parts of Your Gun

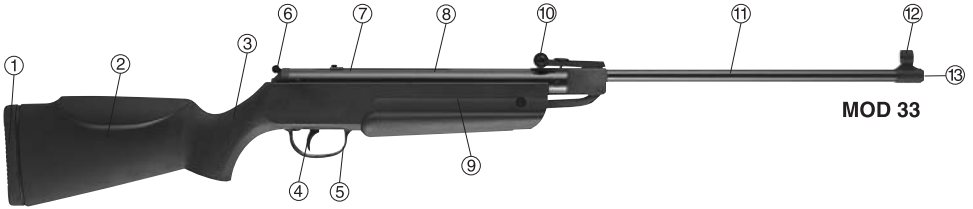

MOD 33

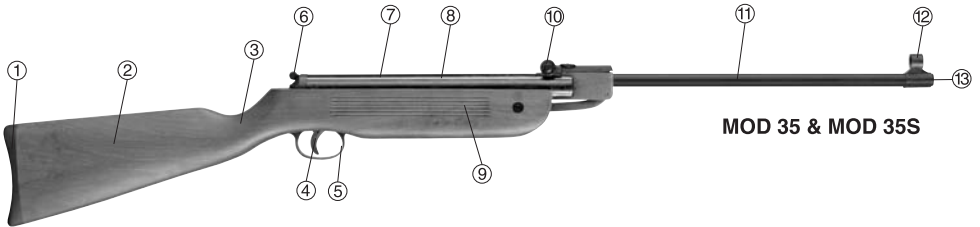

MOD 35 & MOD 35S

1. Butt plate
2. Stock
3. Pistol grip
4. Trigger
5. Trigger guard

6. Safety button (Mod 35S & Mod 33 only)
7. Dovetail grooves
8. Cylinder
9. Forearm
10. Rear - Sight

11. Barrel
12. Front-sight
13. Muzzle

GB

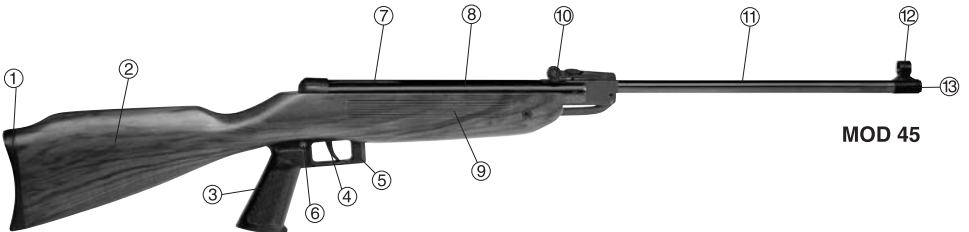

MOD 45

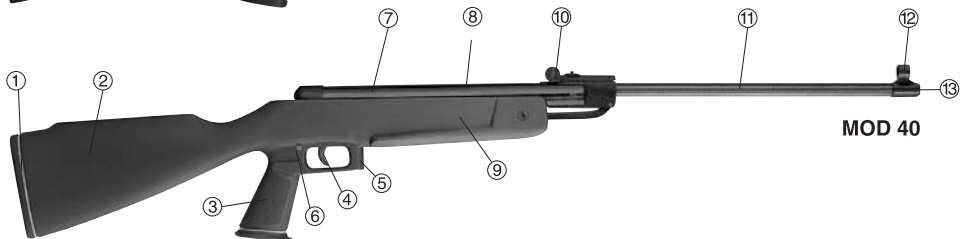

MOD 40

1. Butt plate
2. Stock
3. Pistol grip
4. Trigger
5. Trigger guard

6. Safety button
7. Dovetail grooves
8. Cylinder
9. Forearm
10. Rear - Sight

11. Barrel
12. Front-sight
13. Muzzle

Section II. Manual Safety

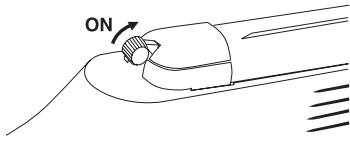

Fig 1-A

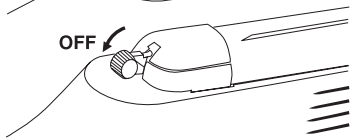

Fig 1-B

MOD 35S & MOD 33

Safety button can be set to 'ON' and 'OFF' position manually.

- To set the safety to 'ON', push safety button upwards. In this position, the trigger cannot be pulled and the gun cannot be fired. (Fig.1-A)
- To remove the safety to 'OFF', pull safety button downwards. In this position, the gun is ready to shoot. (Fig. 1-B)



CAUTION: Until you are actually ready to shoot, keep the safety button in the "ON" position (Fig. 1-A).

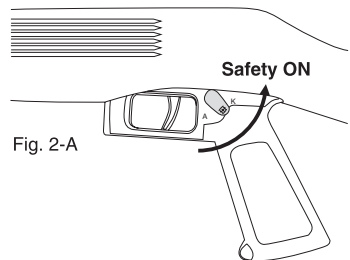

Fig. 2-A

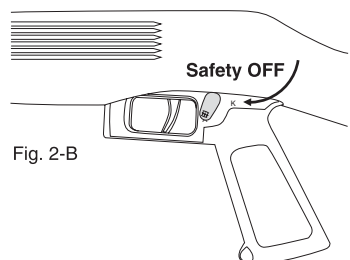

Fig. 2-B

MOD 40 & MOD 45

Safety button can be set to 'ON' and 'OFF' position manually.

- Trigger safety is ON when the safety button is as in Fig. 2-A
- Trigger safety is OFF when the safety button is as in Fig. 2-B. In this position, the gun is ready to shoot.



CAUTION: Until you are actually ready to shoot, keep the safety button in the "ON" position (Fig. 2-A).

Section III. Automatic Safety & Anti Bear-Trap Mechanism (MOD 35S & MOD 33 only)

This air rifle is equipped with automatic safety and anti bear-trap mechanism. Automatic safety sets the safety to "ON" automatically during cocking of the air rifle. Anti bear-trap mechanism prevents the safety button being put to "OFF" position when the cocking arm is broken. Automatic safety & anti bear-trap mechanism together prevents accidental pull of the trigger when the air rifle is cocked, so preventing undesirable charges which may cause damage.

Section IV. Adjustable Trigger (MOD 35, MOD 35S & MOD 33 only)

This air rifle equipped with adjustable trigger for "trigger travel"

Trigger travel adjustment

Trigger travel adjustment can be made by playing with the screw #1.

- For less travel of the trigger prior to discharge; turn clock-wise the screw #1.
- For more travel of the trigger prior to discharge; turn counter-clock wise screw #1.

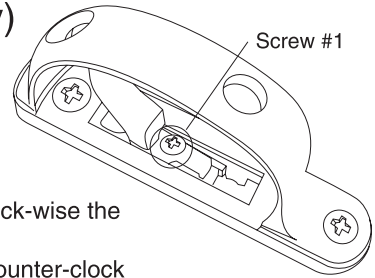

Section V. Micro Adjustable Rear-Sight

The rear-sight is a sensitive device and can be adjusted both for elevation and windage by steps of 0.1 mm, meaning 1 mm deviation when shooting to a target 10 m away.

Windage adjustment

- If the shot is deflected to the left of the target, turn the KNOB1 clockwise. (Fig. 3)
- If the shot is deflected to the right of the target, turn the KNOB1 counter-clockwise. (Fig. 3)

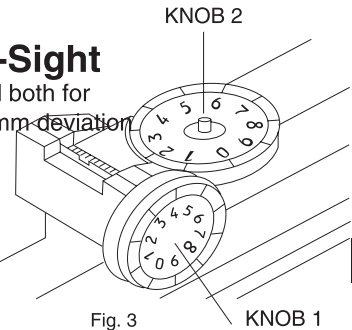

GB

Elevation adjustment

- If the shot is too high, turn KNOB2 clockwise. (Fig. 3)
- If the shot is too low, turn KNOB2 screw counter-clockwise. (Fig. 3)

Section VI. Operation Instructions

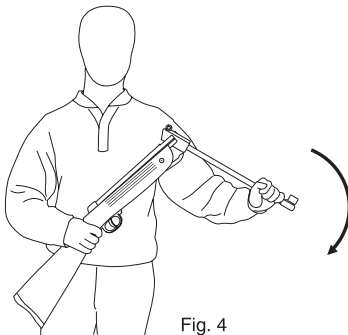

Fig. 4

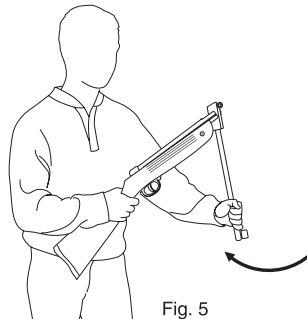

Fig. 5

Cocking the gun:

Hold the pistol grip with one hand and by placing the stock on your hip, break the barrel all the way down with the other hand (Fig. 4 & 5). Here you will notice that the safety button set to 'ON' position automatically even if you left it in 'OFF' position, which is due to automatic safety (MOD 33 & 35S only - see Section III)



CAUTION: Do not leave the gun cocked for a long time. Otherwise the spring may be subject to fatigue, which decreases the performance of the gun.

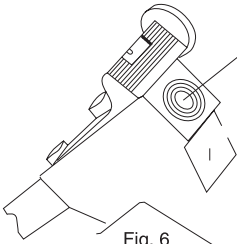

Fig. 6

Loading the gun:

Load the gun with only one pellet. (Fig. 6)

Shooting:

- Bring the barrel to its fully closed position. (Fig. 7)
- Be sure that the barrel is closed completely and you hear a click upon closing the barrel.
- Sight in*, disengage safety and get ready for shooting (Fig. 8)

(*)The gun is correctly aimed when the front sight blade is positioned exactly in the notch of the rear sight. The sight picture should look like Fig. 9.

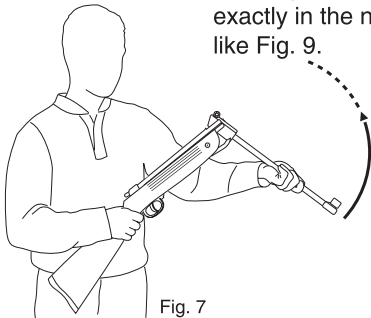

Fig. 7

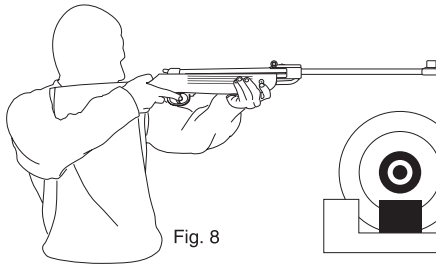

Fig. 8

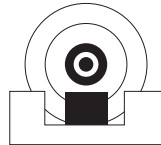

Fig. 9

Section VII. Ammunition

Proper use of ammunition

There is, available, a variety of pellet types of varying weights that can be loaded in your air gun;



Dome head

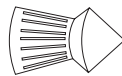

Pointed head

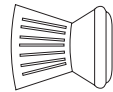

Flat head

The choice of pellet type and weight is very dependent on the intended purpose of the shoot. So, it is recommended to use:

- Flat head pellets for close range shooting and for extreme accuracy
- Dome head pellets for greater impact on the target
- Pointed pellets for considerable expansion
- Heavy weight pellets, especially heavy weight dome head pellets, for maximum penetration & expansion at the target.

Pellet weight and external shape combination plays a very important role on the muzzle velocity and ballistic performance, but weight has the dominant role. Lighter pellets provide higher velocities, usually produce less recoil and give a flatter trajectory path to the target-leads to less guesswork. On the other hand, heavy pellets are more accurate and retain more energy downrange so giving a greater penetration and expansion on the target.

Safety Measures for Ammunition

- Pellet quality is highly important in order to have effective results. So, use only high quality factory-manufactured pellets.
- Never reuse pellets.
- Do not touch face or mouth after handling pellets. Wash hands after handling pellets.
- Do not oil pellets nor use dirty, corroded, bent, damaged or wet pellets.
- **USE ONLY THE PELLETS OF THE CALIBER, WHICH YOUR AIRGUN IS CHAMBERED.**
- Always load your gun with only one pellet and be sure to load the pellet with the skirt end toward you.
- If you feel unusual resistance when loading a pellet or a shot which sounds not normal, immediately check the barrel for a possible obstruction.
- If a pellet obstructs the barrel, do not try to remove it by firing with a subsequent pellet. This may cause serious damage to the rifle and cause serious injury to you or bystanders. In such a case, first try to remove it with a cleaning rod firstly making sure that the rifle is uncocked. If it still cannot be removed take the air gun to a qualified gunsmith.

Section VIII. Technical Specifications

Mechanism	: Break-barrel, single cocking system and single shot
Safety	: Manual trigger safety (MOD 40 & MOD 45 only) Manual & Automatic Safety with anti-bear trap mechanism (MOD 33 & MOD 35S only)
Overall length	: 1050 mm (41 inches)
Barrel length	: 450 mm (17.7 inches)
Weight	: Mod 33 → 2.6 kg (5.7 lbs) Mod 35 → 2.7 kg (5.95 lbs) Mod 35S → 2.7 kg (5.95 lbs) Mod 40 → 2.5 kg (5.5 lbs) Mod 45 → 2.5 kg (5.5 lbs)
Caliber	: 4.5 mm (.177)
Max. muzzle velocity	: See table 1

GB

Table 1

Country	Max. Muzzle Velocity*	
	m/s	ft/s
France	200	650
Sweden	200	650
Germany	170	570
Italy	170	570
UK	170	570
New Zealand	check with dealer	
Others**	200	650

*muzzle velocity is very dependent on the pellet weight and the pellet shape

**those which have no muzzle velocity or energy restriction

Section IX. Care, Cleaning & Lubrication

- Protect your air gun with gun oil periodically. It is very important and necessary to oil your air gun when it is
 - Not used for a long time
 - Shot under dry & dusty conditions
 - Used in wet weather (oil it before & after use in such a case)
- It is recommended to oil your gun every 250 shots.
- It is recommended to clean the barrel with a cleaning rod every 500 shots.
- Before you begin oiling or cleaning your air gun, always check to make sure it is unloaded.
- Always be sure your gun barrel is clean and not blocked.
- After cleaning check to be sure that no cleaning patch or other obstruction remains in the barrel.
- Annually, take your air gun to a gunsmith even if it seems to be working well, since some issues in your gun may not be apparent from external examination.
- Take your air gun to a gunsmith if water, sand, etc. enters the internal mechanism of the air gun, for complete cleaning.
- Dangerous conditions may occur if you do not keep your air gun clean and working properly.

Safety Measures & Warnings

- This airgun will fire if cocked, loaded, safety disengaged and trigger pulled.
- Air guns are not toys. Never let young children use an airgun unsupervised. Adult supervision is strictly required during use. Misuse or careless use may cause serious injury or death.
- Learn how your air gun operates and safe gun handling procedures before loading and using it.
- ALWAYS USE EYE & HEARING PROTECTION AND MAKE BYSTANDERS USE THE SAME. Failure to do so may result in eye injuries and permanent hearing loss.
- Do not point at anything you do not intend to shoot even though the gun is unloaded. Always keep the gun pointed in a safe direction.
- Never pull a gun toward you by the muzzle.
- Always aim at a safe target, taking care that it does not conceal any other object.
- Before you fire, consider where the pellet will travel should you miss your intended target, thus ensuring no damage or harm could result.
- Be sure of your target before you pull the trigger. Never shoot at sounds.
- When shooting, always have a *safe shooting range*, that is; have a safe area for shooting, a safe distance between you and the target, and a safe backstop to trap the pellets and hold the target.
- Do not fire at a target, which allows ricochets or deflections.
- Do not fire into or at water.
- Do not fire at or near power lines or insulators. Be especially careful in wooded areas where power lines may not be as visible.
- Do not load the gun until you are ready to shoot.
- Always keep your fingers away from the trigger & muzzle during cocking and handling.

- Do not walk, run or jump when carrying a loaded or cocked air gun. A loaded or a cocked gun should never be carried inside a vehicle, house, camp or public place. Never climb a tree or fence or jump a ditch with a loaded gun. In such a case, first unload it and hand the gun to a friend or place it on the ground on the other side of the obstacle before crossing yourself.
- When transporting the gun, keep it unloaded and 'on safe'.
- Always keep the gun 'on safe' until you are ready to shoot even if the gun is unloaded.
- Do not put the gun away loaded and unattended.
- Always check to see if the gun is 'on safe' and unloaded when getting it from another person or from storage.
- **ALWAYS KEEP THE AIR GUN AND/OR PELLETS OUT OF THE REACH OF CHILDREN.**
- Keep the airgun and pellets in separate places, better if under lock and key.
- Do not attempt to disassemble or tamper with your gun. Use a competent gunsmith. Many air guns contain powerful springs which can cause serious injury if released in an uncontrolled manner.
- Always handle and treat your gun as though it were loaded.
- Improper use or handling of air guns is not the responsibility of the manufacturer or distributor, under any circumstances. The user is responsible for any harm, which may be caused.
- Think first, fire second.
- Don't rely on any mechanical safety. Half safe is not safe.
- Be safe not sorry.
- Respect other's property.
- Air guns should never be used under the influences of alcohol or drugs.



HATSAN ARMS COMPANY

<http://www.hatsan.com.tr> • e-mail: info@hatsan.com.tr